

40 Ω Series

Proportional Electro-Hydraulic Flow Control (and Check) Valves

Since the preselected flow rate continuously varies in proportion to the current input to the valve, the system flow rate can be remote-controlled as desired by regulating the amplifier current output.

Further, since pressure and temperature compensation functions are provided, the preselected flow rate is not affected by pressure (load) or temperature (fluid viscosity).

This valve is ideal for use where actuator startup, stop and speed changes are to be implemented without producing a shock. Note that this valve is used in conjunction with the applicable power amplifier.

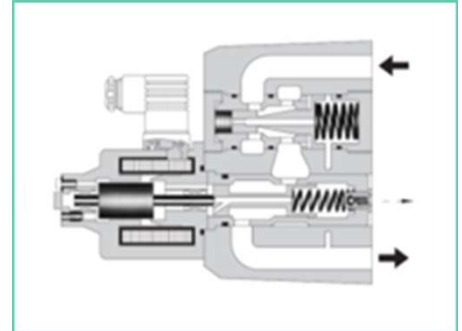

Graphic Symbol

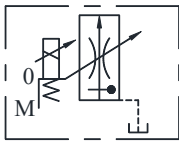

EFG-※

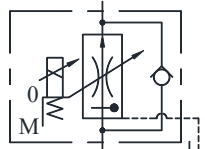

EFCG-※

Specification

Model Number	EF※G02-10-30	EF※G-03-60-125	EF※G-06-250	EF※G-10-500
Max. Operating Pres. Kg/cm ²	210			
Metered Flow Adjustment Range L/min.	10 : 0.3-10 30 : 0.3-30	60 : 2-60 125 : 2-125	3-250	5-500
Min. Differential Pres. Kg/cm ² *1	6	10	13	20
Free Flow (EFCG Models) L/min.	40	130	280	550
Rated Current mA	600			700
Coil Resistance Ω	45			
Hysteresis	Less than 5%		Less than 7%	
Repeatability	Less than 1%			
Mass Kg.	8.2	12.5	25	51

*1 Min. Pressure difference required between inlet and outlet ports to maintain function as pressure compensator.

Model Number Designation

F	EF	G	-02	-10	-31
Special Seals **	Series Number	Type of Mounting	Valve Size	Max. Metered Flow L/min.	Design Number
F: Special Seals for Phosphate Ester Type Fluid (Omit if not required)	EF: Proportional electro-Hydraulic Flow Control Valve	G: Sub-Plate Mounting	02	10 : 10 30 : 30	31
			03	60 : 60 125 : 125	26
	EFC: Proportional electro-Hydraulic Flow Control and Check Valve		06	250 : 250	22
			10	500 : 500	11

Note: If the model with pressure compensator stroke adjustment screw is to be used, consult YUKEN representative in advance.

** Before ordering models with Special seals, consult YUKEN representative

E Series

40 Ω Series Flow Control (and Check) Valves

Attachment

● **Mounting Bolts**

Valve Model Numbers	Socket head Cap Screw	Qty.	Bolt Kit Model Number
EF※G-02	M8 x 75Lg.	4	BKEFG-02-31
EF※G-03	M10 x 100Lg.	4	BKEFG-03-26
EF※G-06	M16 x 130Lg.	4	BKEFG-06-22
EF※G-10	M20 x 160Lg.	4	BKEFG-10-11

Applicable Power Amplifier

For stable performance, it is recommended that YUKEN’s applicable Power Amplifiers be used

Model Numbers:

- AME-D-※-40
- AME-DF-S-※-22
- AME-T-S-※-22

Sub-Plate

Valve Model Numbers	Sub-Plate Model Number	Piping Size	Mass Kg.
EFG EFCG -02	EFGM-02X-2080	3/8 BSP.F	2.3
	EFGM-02Y-2080	1/2 BSP.F	3.1
EFG EFCG -03	EFGM-03Y-2080	3/4 BSP.F	5.7
	EFGM-03Z-2080	1 BSP.F	5.6
EFG EFCG -06	EFGM-06X-2080	1 BSP.F	12.5
	EFGM-06Y-2080	1-1/4 BSP.F	16
EFG EFCG -10	EFGM-10Y-2080	1-1/2, 2 Flange Mounting	37

Sub-Plates are available. Specify sub-plate model from the table above. When sub-plates are not used, the mounting surface should have a good machined finish.

Model with Pressure Compensator Stroke Adjustment Screw

Models with pressure compensator stroke adjustment screw is optionally available to minimize the actuator protrusion (jumping) at startup. Contact your local dealers for details.

Instructions

● **Drain Back Pressure**

Check that the drain back pressure does not exceed 2 Kg/cm²

● **Models with Check Valve**

A models with check valve makes it possible to obtain a free flow in the direction opposite to that of the controlled flow irrespective of the input current.

- **EFG/EFCG-02-※-31**
- **EFG/EFCG-03-※-26**

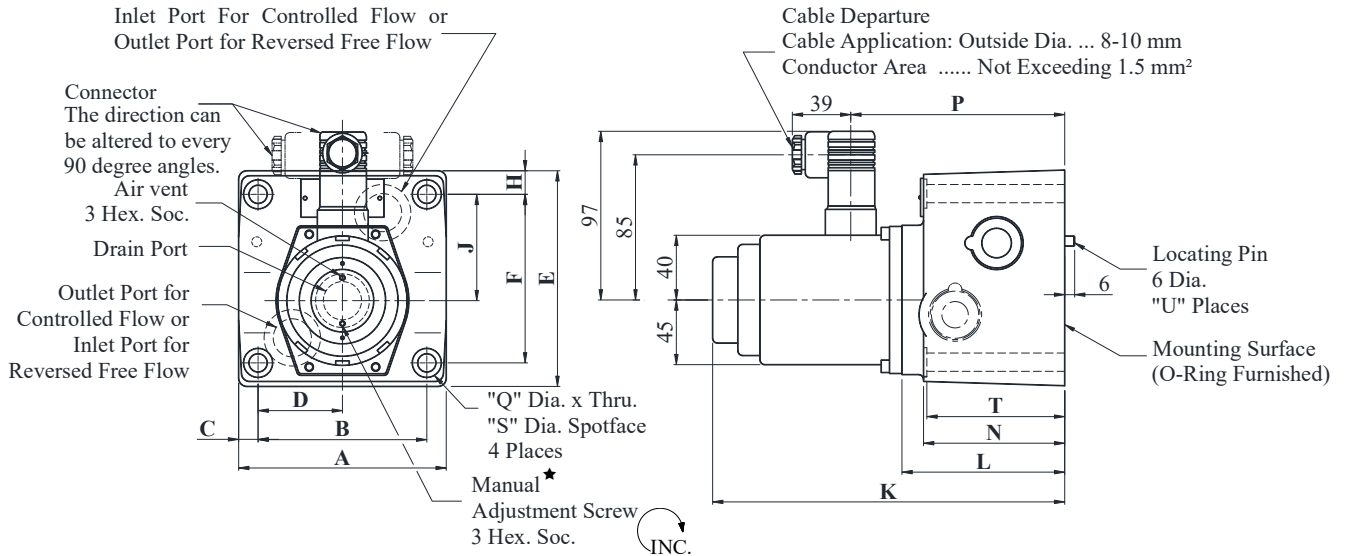

* Manual adjustment can be done by screwing for example an M4x20L screw in the M4 thread or pushing in a rod etc. there.

Model Numbers	Dimensions mm															
	A	B	C	D	E	F	H	J	K	L	N	P	Q	S	T	U
EF※G-02	96	76.2	9.9	38.1	106	82.6	11.7	46.3	195	81	66	108	8.8	14	65	1
EF※G-03	125	101.6	11.7	50.8	130	101.6	14.2	61.8	212	98	85	125	11	17.5	84	2

DIMENSIONS IN MILLIMETRES

- **EFG/EFCG-06-※-22**
- **EFG/EFCG-10-※-11**

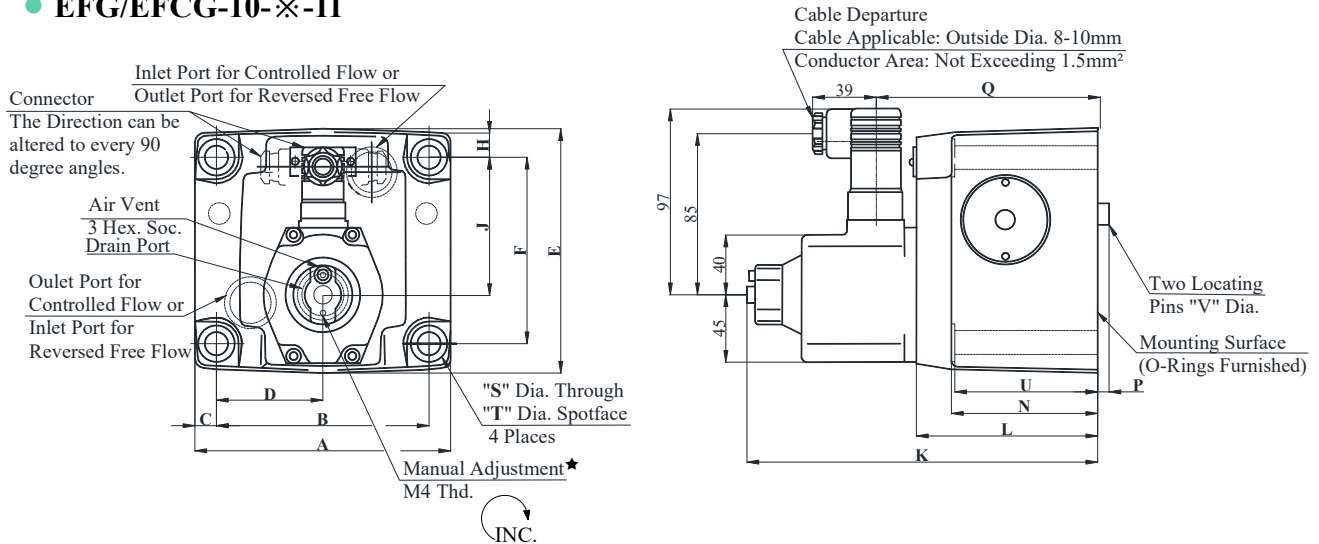

* Manual adjustment can be done by screwing for example an M4x20L screw in the M4 thread or pushing in a rod etc. there.

Model Numbers	Dimensions mm																
	A	B	C	D	E	F	H	J	K	L	N	P	Q	S	T	U	V
EF※G-06	180	146.1	17	73.1	174	133.4	20.3	99	244	130	105	7	157	17.5	26	103.5	16
EF※G-10	244	196.9	23.5	98.5	228	177.8	25	144.5	274	160	137	10	187	21.5	32	135	18

E Series

40 Ω Series Flow Control (and Check) Valves

Sub Plate

EFGM-02X-2080
EFGM-02Y-2080

Model Number	A	B	C	D	"E" Thd.
EFGM-2X-2080	8.6	75.9	25	15.2	3/8 BSP.F
EFGM-2Y-2080	11.5	72.9	35	15	1/2 BSP.F

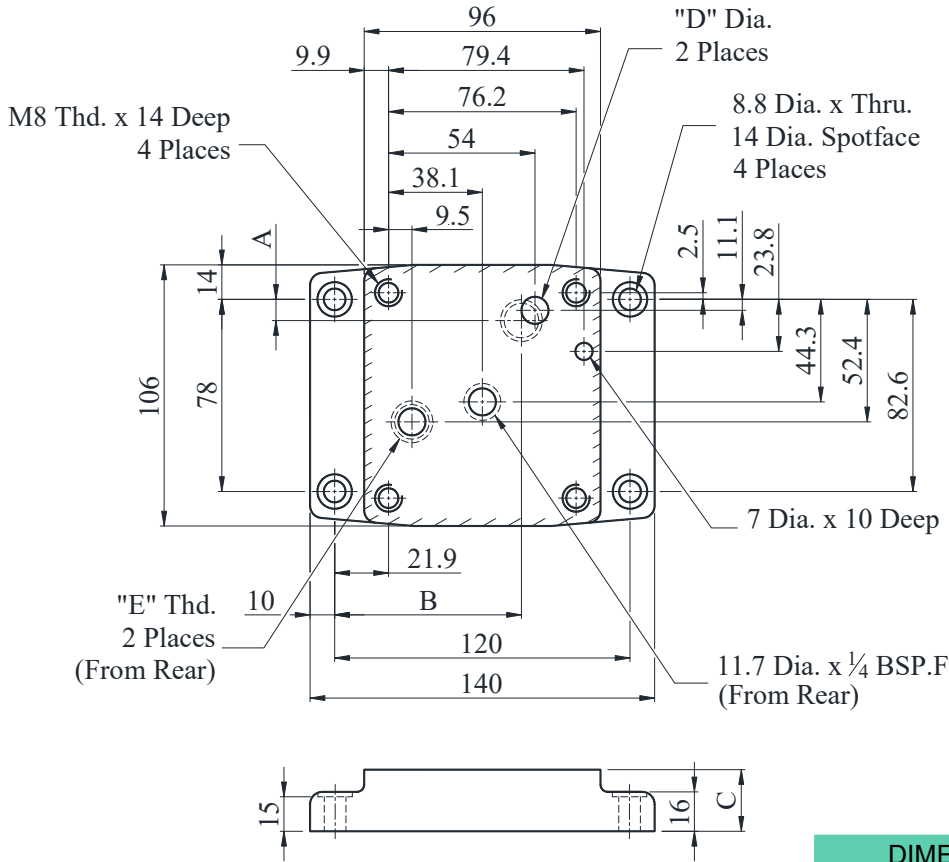

DIMENSIONS IN MILLIMETRES

EFGM-03Y-2080
EFGM-03Z-2080

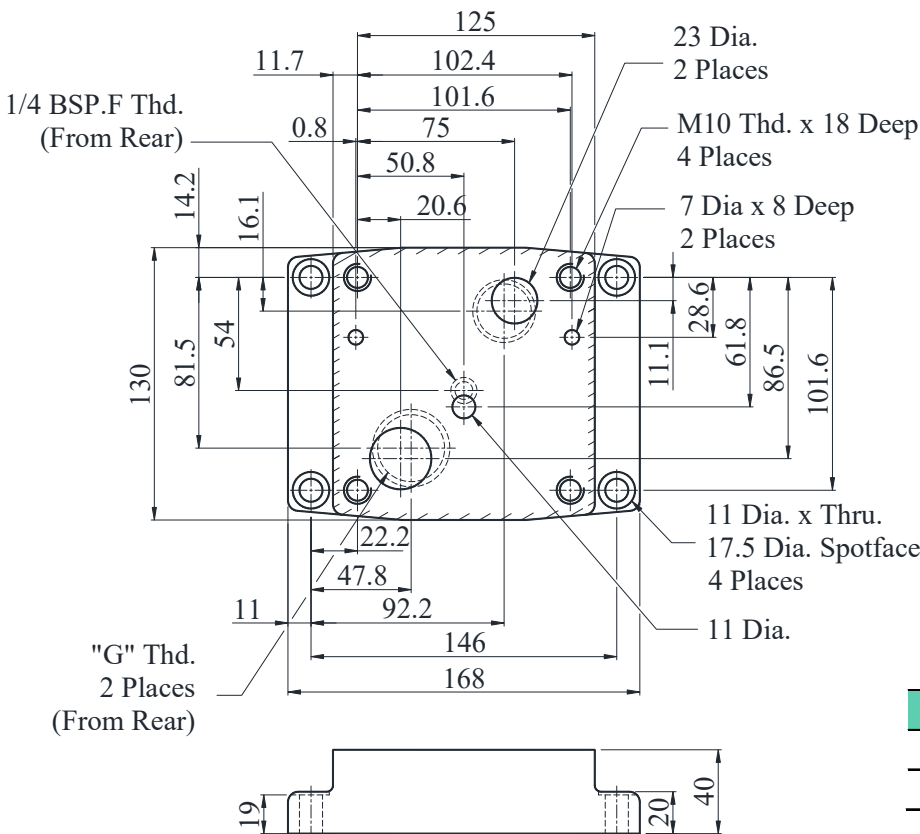

Model Number	"G" Thd.
EFGM-03Y-2080	3/4 BSP.F
EFGM-03Z-2080	1 BSP.F

E Series

40 Ω Series Flow Control (and Check) Valves

Sub Plate

- EFGM-06X-2080
- EFGM-06Y-2080

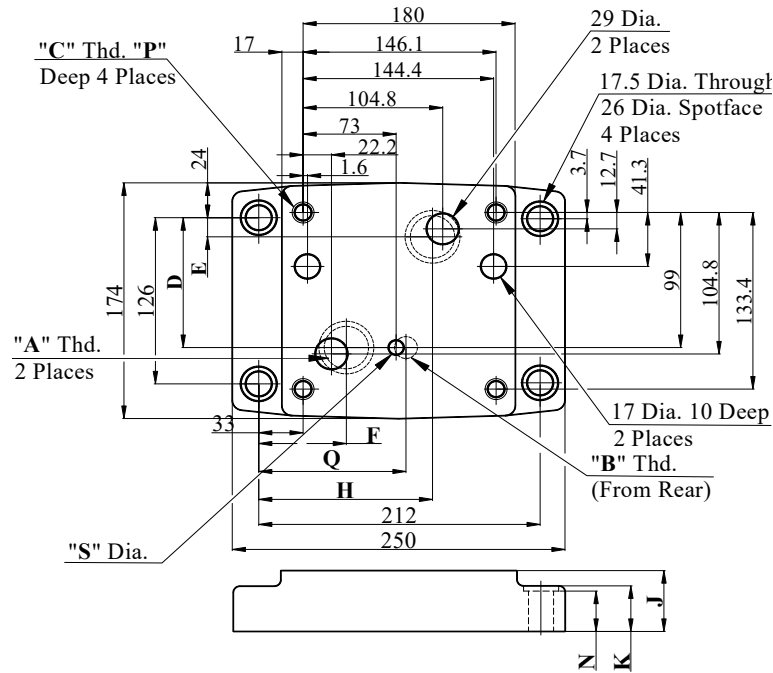

Sub-plate Model Number	Thread Size			Dimensions mm									
	"A" Thd.	"B" Thd.	"C" Thd.	D	E	F	H	J	K	N	P	Q	S
EFGM-6X-2080	1 BSP.F	3/8 BSP.F	M16	101.1	14.3	55.2	137.8	45	35	34	30	116	15.2
EFGM-6Y-2080	1-1/4 BSP.F			95.3	19.3	67	132	60	40	39			15

DIMENSIONS IN MILLIMETRES

- EFGM-10Y-1080

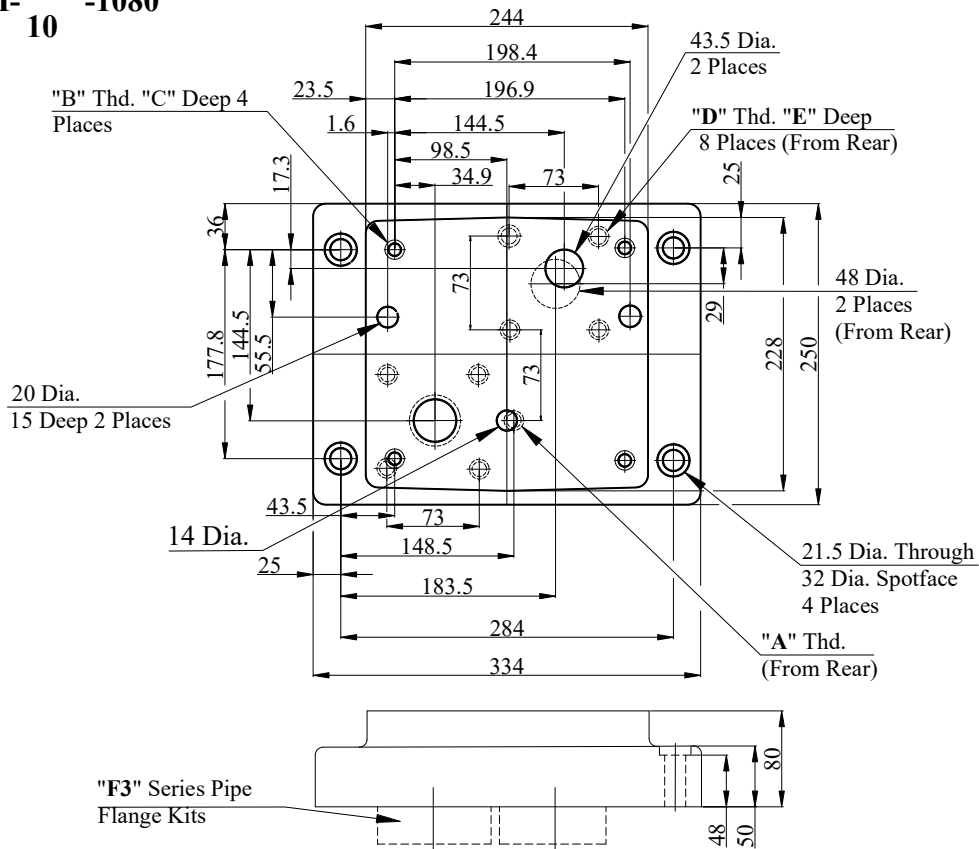

Sub-Plate Model Number	Thread Size				
	"A" Thd.	"B" Thd.	"D" Thd.	"C" Thd.	"E" Thd.
EFGM-10Y-1080	3/8 BSP.F	M20	M16	30	30

E Series

40 Ω Series Flow Control (and Check) Valves

Input Current vs. Flow

Viscosity : 30mm²/s

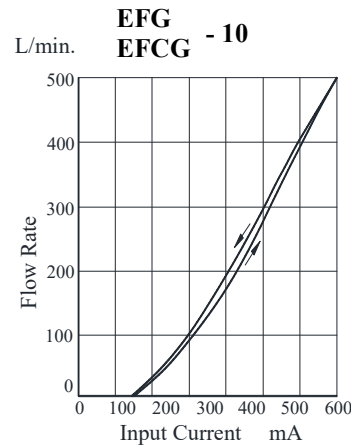
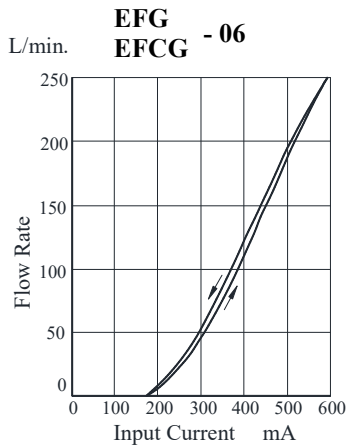
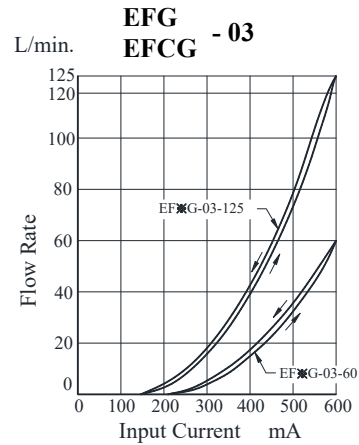
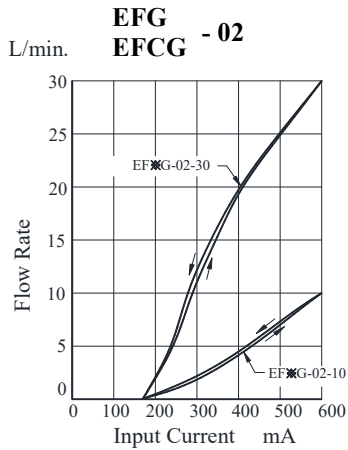

Differential Pressure vs. Metered Flow

Viscosity : 30mm²/s

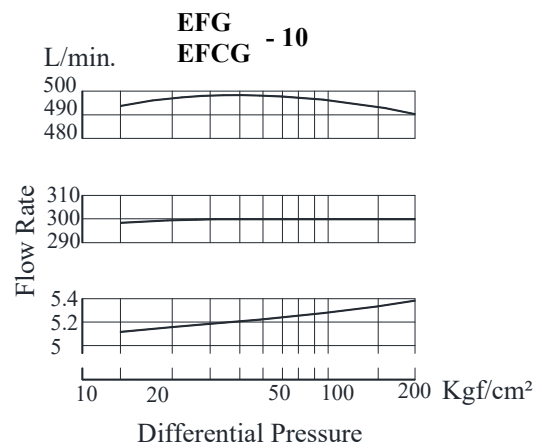
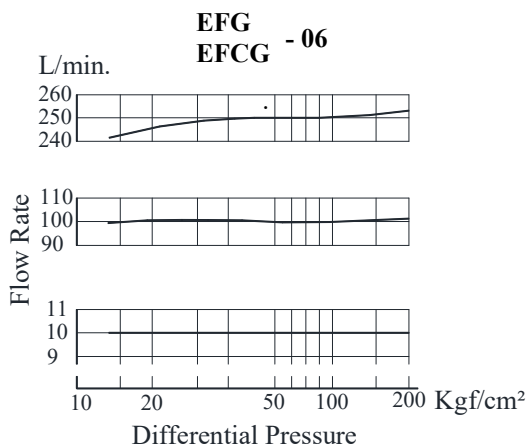
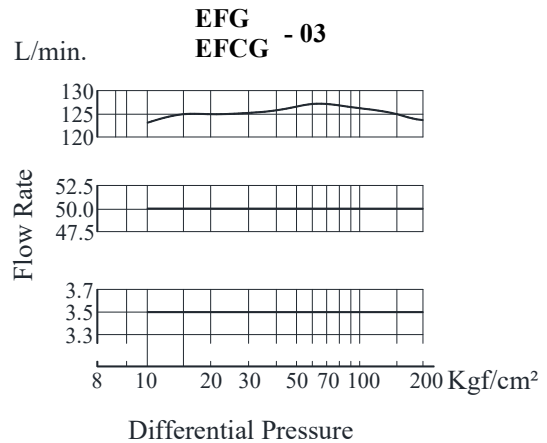
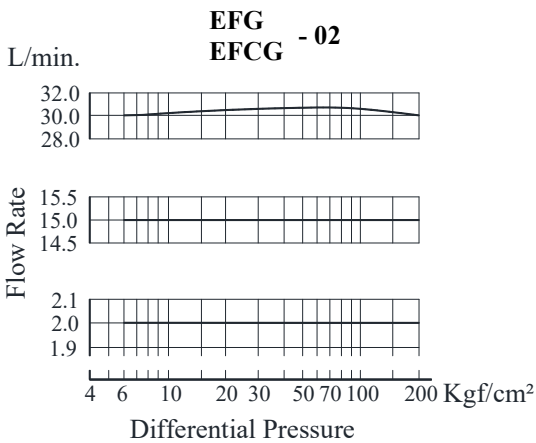

H
Proportional Electro-Hydraulic
Flow Control (and Check) Valve

Step Response

These characteristics have been obtained by measuring on each valve. Therefore, they may vary according to a hydraulic circuit to be used.

Viscosity : 30mm²/s

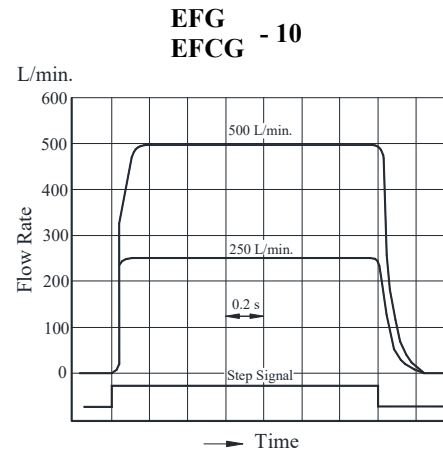
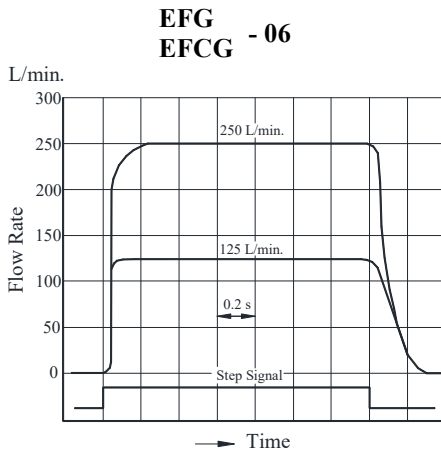
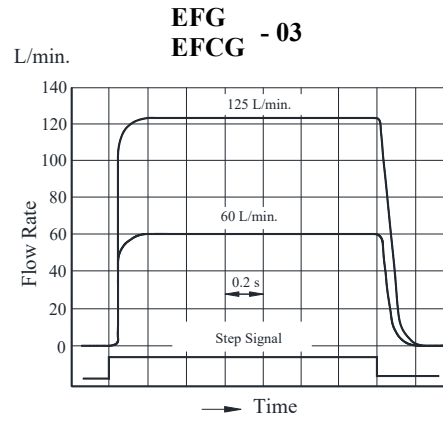
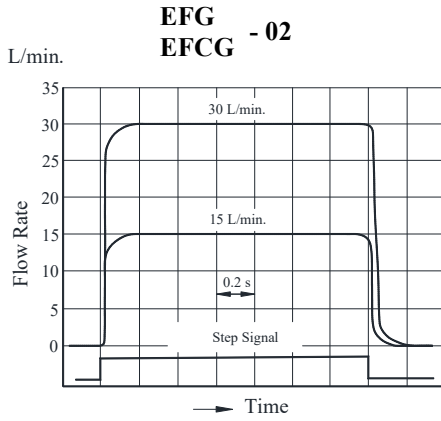

Frequency Response

Viscosity : 30mm²/s

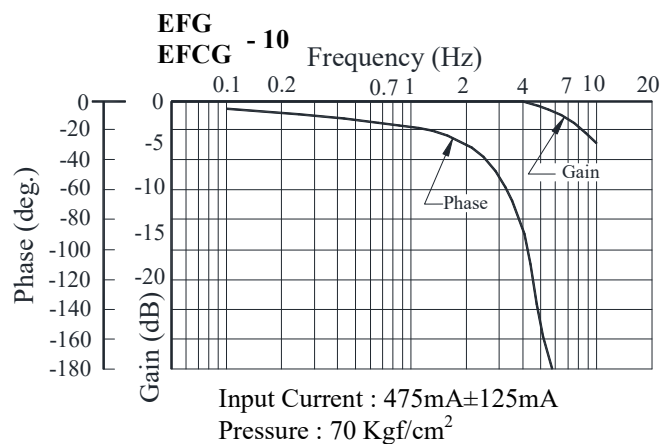
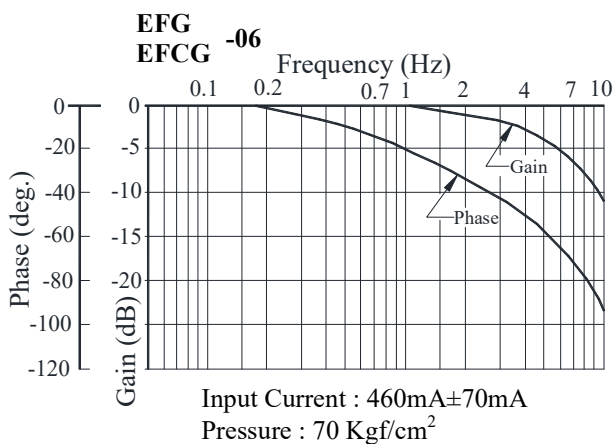
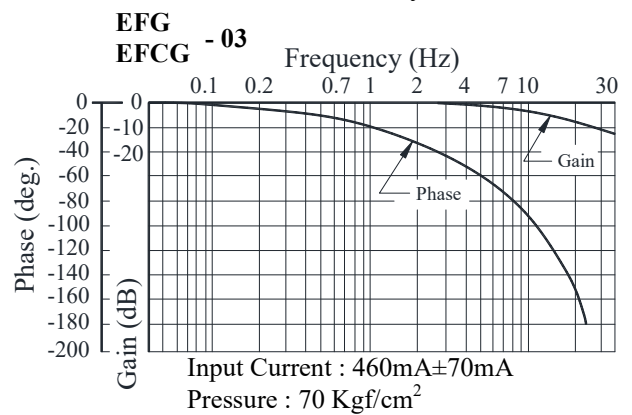
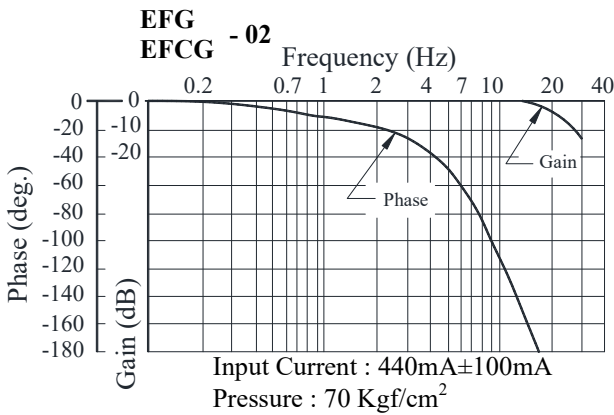

E Series

40 Ω Series Flow Control (and Check) Valves

■ Viscosity vs. Flow

Oil : ISO VG 46

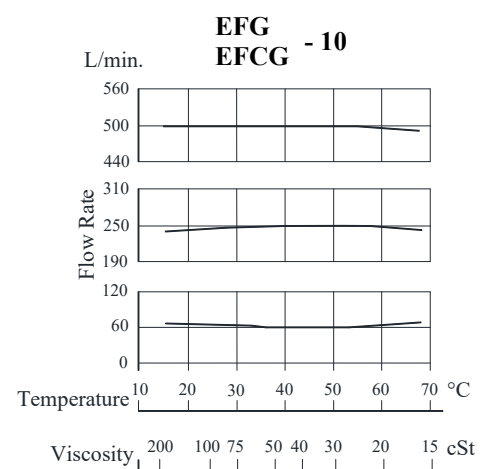
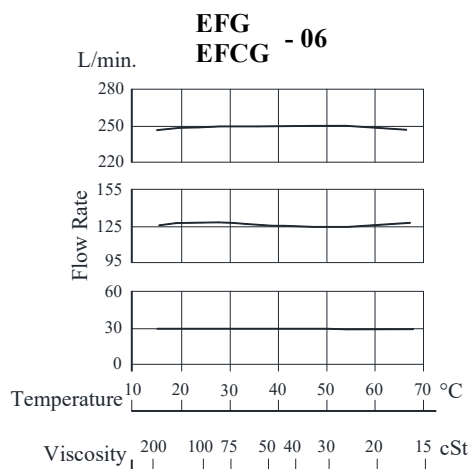
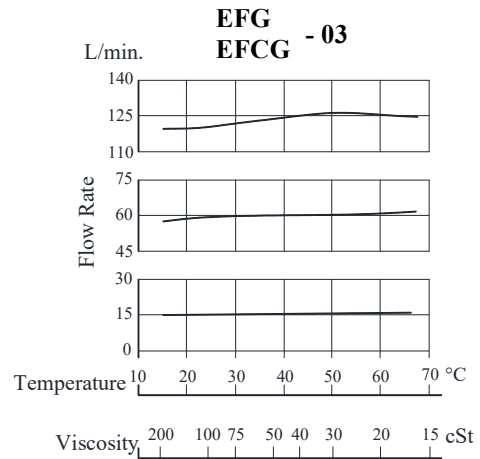
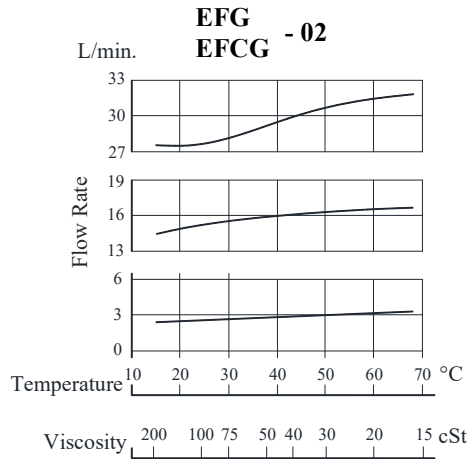

■ Pressure Drop Reversed Free Flow (Only for Models With Check Valves)

Oil Viscosity : 35mm²/
Specific Gravity : 0.850

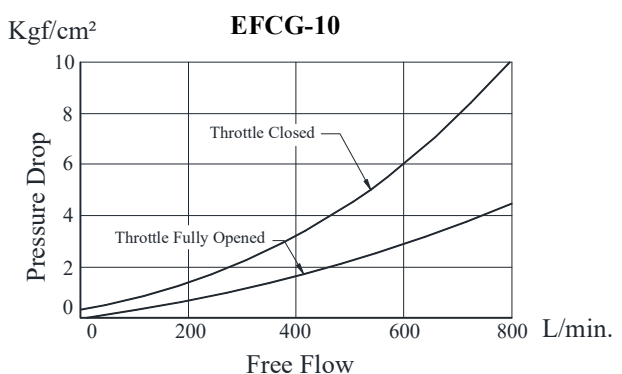
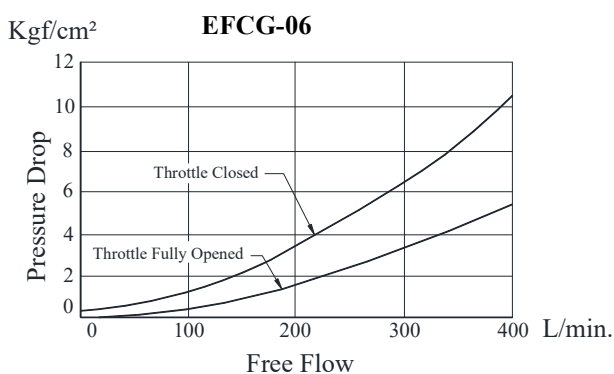
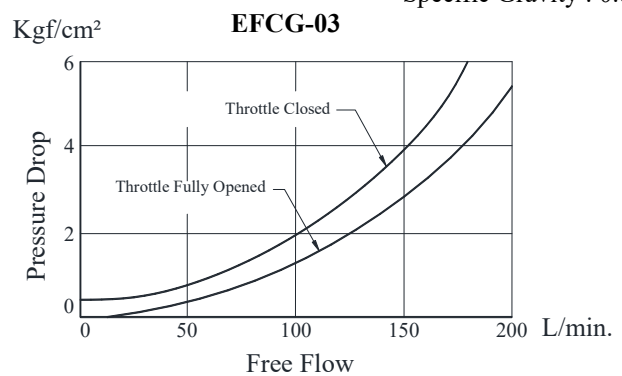
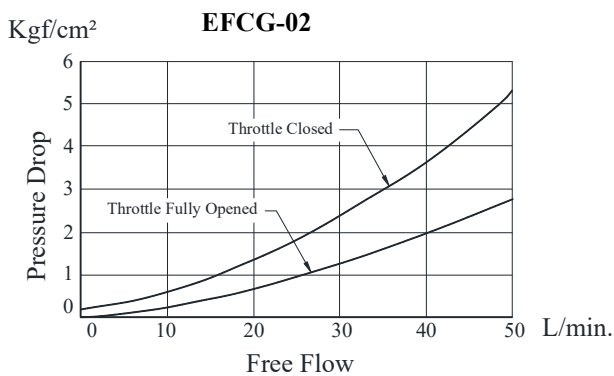

E Series

40 Ω Series Flow Control (and Check) Valves

- For any other viscosity, multiply the factors in the table below.

Viscosity	cSt	20	40	60	80	100
Factor		0.87	1.03	1.14	1.23	1.30

- For any other specific gravity (G'), the pressure drop ($\Delta P'$) may be obtained from the formula below.
 $P' = \Delta P (G'/0.85)$

Spare Parts List

List of Seals

Sl. No.	Name of Parts	Part Numbers		Qty.	Part Numbers		Qty.
		EF※G-02	EF※G-03		EF※G-06	EF※G-10	
1	Solenoid Ass'y	E321-45-20	E321-45-20	1	E321-45-20	E321-45-20	1
2	O-Ring	SO-NB-P18	SO-NB-P18	1	SO-NB-P50	SO-NB-G75	3
3	O-Ring	SO-NB-P10A	SO-NB-P21	1	SO-NB-P44	SO-NB-G60	1
4	O-Ring	SO-NB-P18	SO-NB-P28	2	SO-NB-P34	SO-NB-P50	1
5	O-Ring	SO-NB-P22	SO-NB-P31	1	SO-NB-P32	SO-NB-P48	2
6	O-Ring	SO-NB-G25	SO-NB-G35	1	SO-NB-P21	SO-NB-P34	1
7	O-Ring	-	SO-NB-P18	1	SO-NB-P21	SO-NB-P26	1
8	O-Ring	SO-NB-P22	-	1	SO-NB-P10	SO-NB-P10	1
9	O-Ring	SO-NB-G45	SO-NB-G45	1	SO-NB-G45	SO-NB-G45	1
10	O-Ring	SO-NB-G35	SO-NB-G35	1	SO-NB-G35	SO-NB-G35	1
11	O-Ring	SO-NA-P4	SO-NA-P4	1	SO-NA-P4	SO-NA-P4	1
12	Fastener Seal	SG-FCF-4	SG-FCF-4	1	SG-FCF-4	SG-FCF-4	1

Note:

When Ordering the seals, please specify the seal kit numbers from the table below.

List of Seal Kits

Model Numbers	Seal Kit Numbers
EFG-02-※-31※	KS-EFG-02-31
EFCG-02-※-31※	KS-EFCG-02-31
EFG-03-※-26※	KS-EFG-03-26
EFCG-03-※-26※	KS-EFCG-03-26
EFG-06-250-22※	KS-EFG-06-22
EFCG-06-250-22※	KS-EFCG-06-22
EFG-10-500-11※	KS-EFG-10-11
EFCG-10-500-11※	KS-EFCG-10-11

10Ω Series

Proportional Electro-Hydraulic Flow Control (and Check) Valves

Since the preselected flow rate continuously varies in proportion to the current input to the valve, the system flow rate can be remote controlled as desired by regulating the current output from the amplifier. Further, since the pressure and temperature compensation functions are provided, the preselected flow rate is not be affected by pressure (load) or temperature (fluid viscosity).

This valve is ideal for use where actuator startup, stop, and speed changes are to be implemented without producing a shock. Note that this valve is used in conjunction with the applicable power amplifier.

Specifications

Description		Model No.	EF※G-03- 60 125	EF※G-06-250
Max. Operating Pres.	Kgf/cm ²		210	250
Metered Flow adj. Range	L/min.		60: 1 ~ 60 125: 1 ~ 125	2.5 ~ 250
Min. Differential Pressure *1	Kgf/cm ²		10	
Free Flow (EFCG Models only)	L/min.		130	280
Min. Pilot Pressure *2	Kgf/cm ²		10	15
Pilot Flow L/min.	At Normal		0.5	1
	At Transition		2.6	4
Rated Current	mA		780	820
Coil Resistance	Ω		10	
Hysteresis			Less than 3%	
Repeatability			Less than 1%	
Approx. Mass	Kg.		10	25

*1. Minimum pressure difference required between inlet and outlet ports to maintain function as pressure compensator.

*2. The minimum required value for the external pilot type.

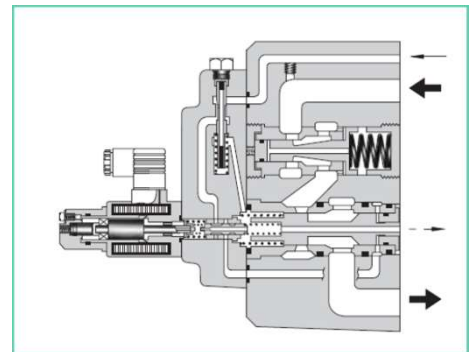

Graphic Symbols

● EFG-※

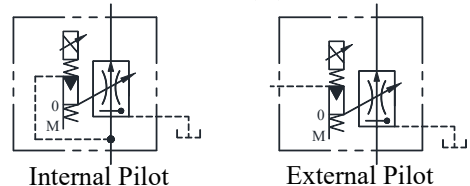

● EFCG-※

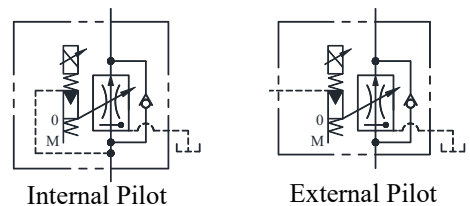

Model Number Designation

F-	EF	-G	-03	-60	-E	-51
Special Seals**	Series Number	Type of Mounting	Valve Size	Max. Metered Flow L/min.	Pilot Connection	Design Number
F: Special Seals for Phosphate Ester Type Fluid (Omit if not required)	EF: Proportional Electro-Hydraulic Flow Control Valve	G: Sub-Plate Mounting	03	60: 60 125: 125	None: Internal Pilot E: External Pilot	51
	EFC: Proportional Electro-Hydraulic Flow Control and Check Valve		06	250: 250		

** Before ordering the models with Special seals, consult YUKEN representative

E Series

10Ω Series Flow Control (and Check) Valves

Mounting Bolts

Model Number	Socket head cap Screw	Qty	Bolt Kit Model Number
EFG-03 EFCG-03	M10 x 80Lg.	4	BKEFG-03-51
EFG-06 EFCG-06	M16 x 130Lg.		BKEFG-06-51

Sub-Plate

Sl. No.	Model Number	Sub-Plate Model Numbers	Thread size	Mass Kg.
1	EFG-03	EFGM-03Y-2080	3/8 BSP.F	5.7
	EFCG-03	EFGM-03Z-2080	1 BSP.F	5.6
2	EFG-06	EFGM-06Y-2080	1 BSP.F	12.5
	EFCG-06	EFGM-06Z-2080	1 1/4 BSP.F	16

- Sub-plates are available. Specify the sub-plate model number from the table above. When sub-plates are not used, the mounting surface should have a good machined finish.
- For Sub-plates details please refer page No. 587.

Applicable Power Amplifier

For suitable performance, it is recommended that YUKEN's applicable power amplifiers be used

Model Numbers:

- AME-D-10-※-20
- AME-D2-1010-11
- SK1022-※-※-11
- SK1015-11 (For DC Power supply)
- AMN-D-10 (For DC Power supply)

Instructions

Drain Back Pressure

Check that the drain back pressure does not exceed 2 Kgf/cm².

Pilot Type Selection

This valve is constructed so as to operate at a predetermined pilot pressure, for the 03, a pilot pressure of 10 Kgf/cm² or higher is required. For the 06, the required pilot pressure is 15 Kgf/cm² or higher.

To obtain such a required pilot pressure, select the pilot type according to the circuit examples on the right.

①②

Use the external pilot type (Pilot connection code : E) whether a meter-in or meter-out circuit is employed.

③

Use the internal pilot type (Pilot connection code : None)

④

Use the external pilot type (Pilot connection code : E)

Example of Circuit

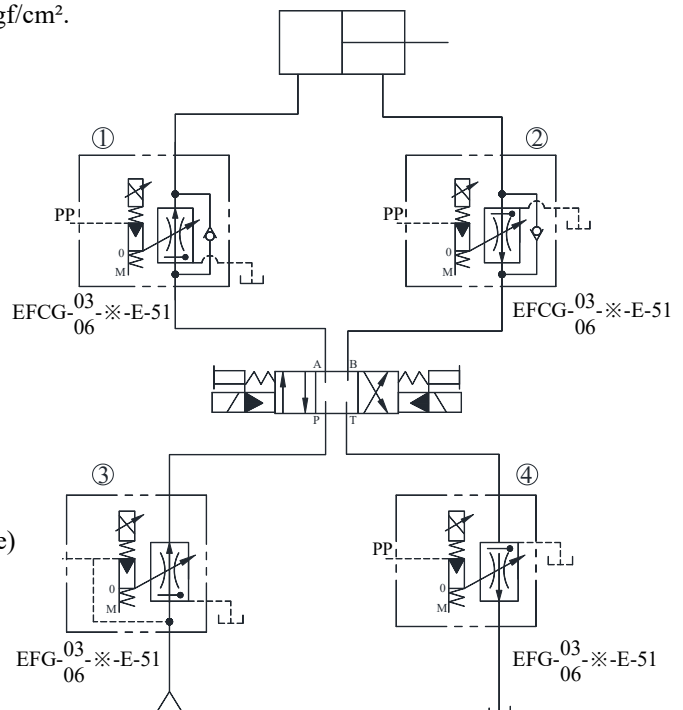

- EFG 03-60-※-51
- EFCG 125

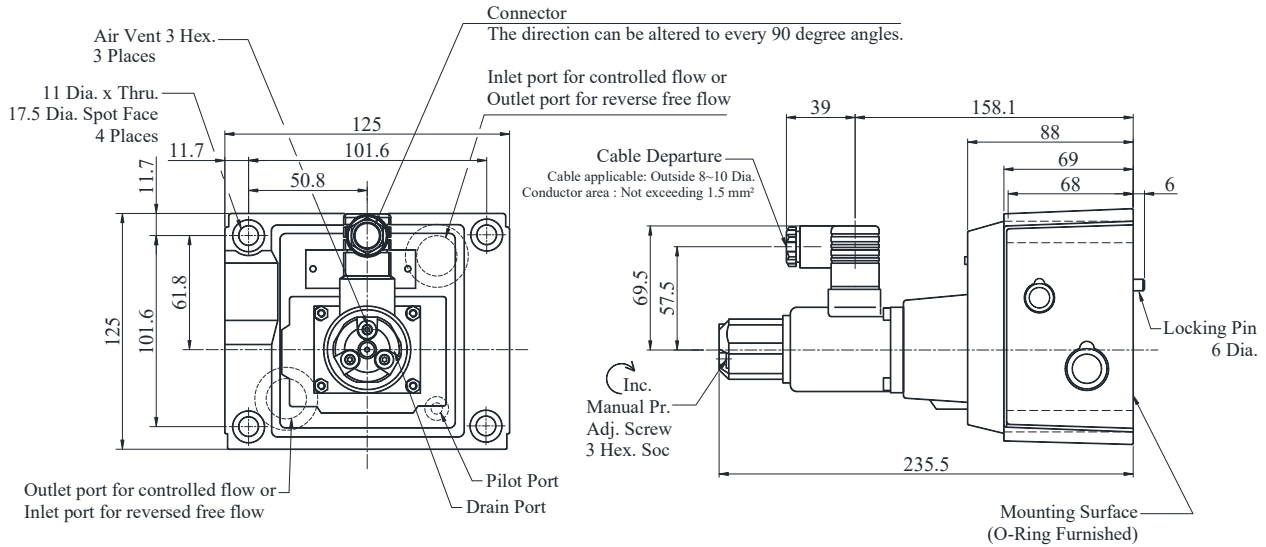

DIMENSIONS IN MILLIMETRES

- EFG 06-250-※-51
- EFCG

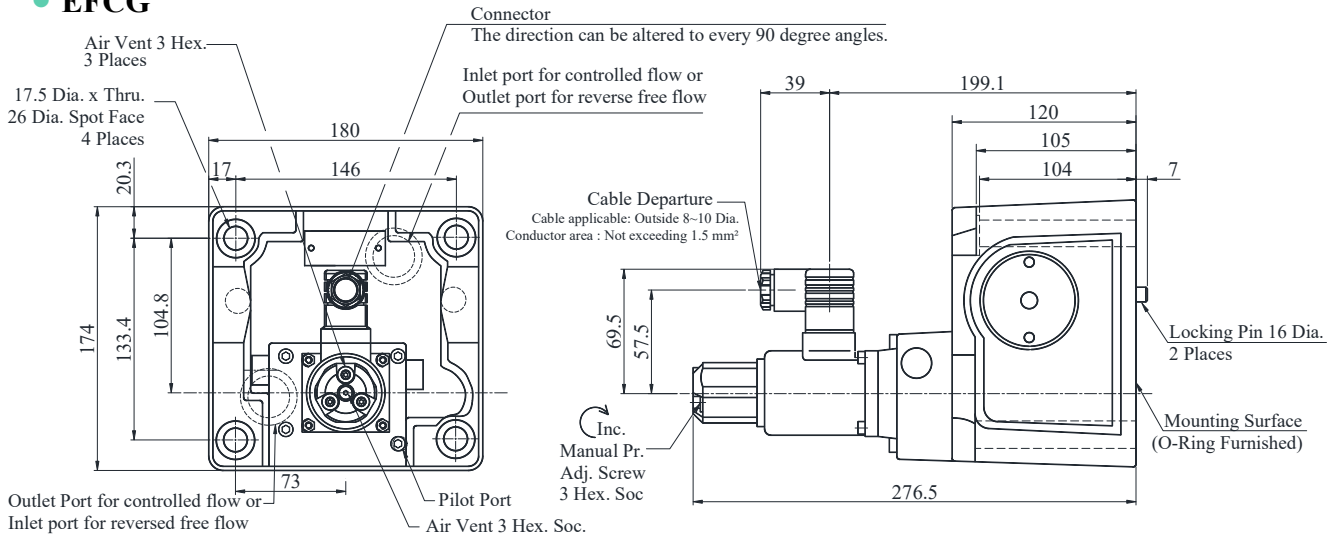

Input Current Vs. Flow

Viscosity : 30 cSt

- EFG 03
- EFCG

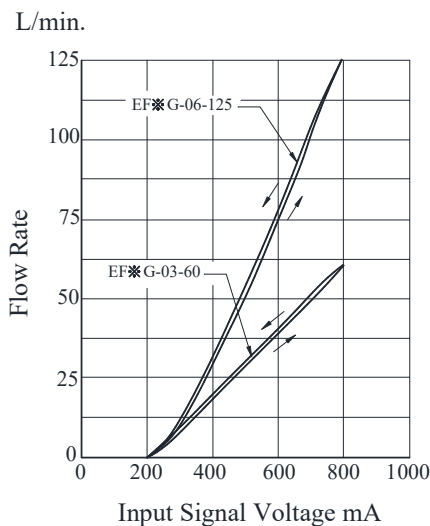

- EFG 06
- EFCG

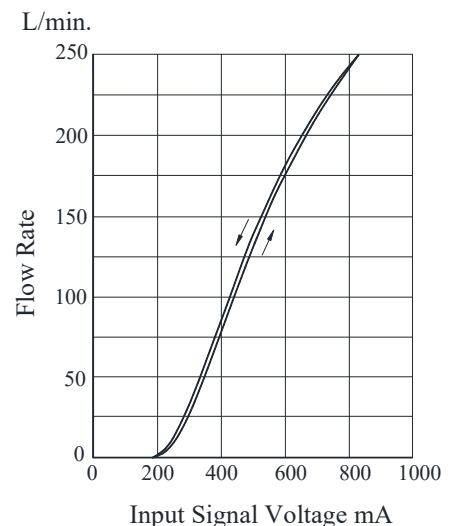

E Series

10Ω Series Flow Control (and Check) Valves

Step Response (Example)

Viscosity : 30 cSt

These characteristics have been obtained by measuring on each valve. therefore, they may vary according to a hydraulic circuit to be used.

- EFG 03
- EFCG

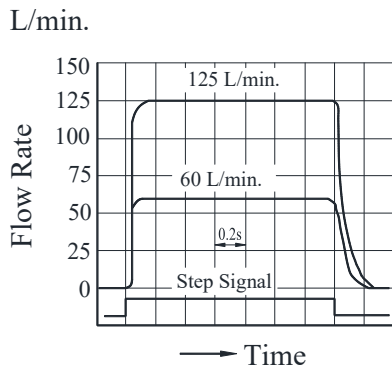

- EFG 06
- EFCG

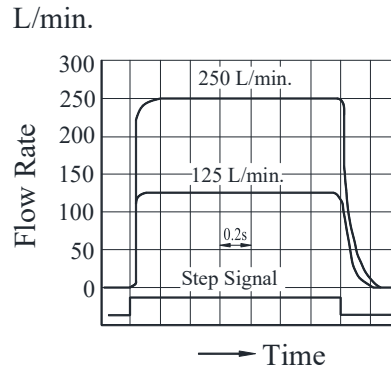

Frequency Response

Viscosity : 30 cSt

- EFG 03
- EFCG

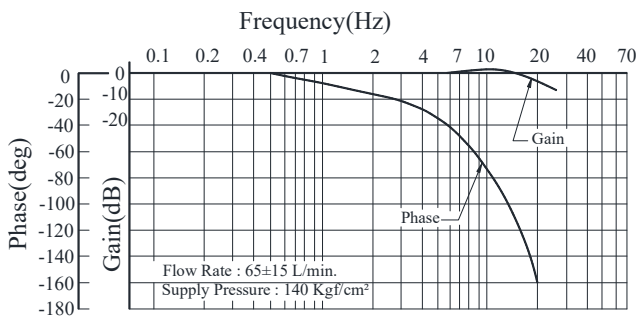

- EFG 06
- EFCG

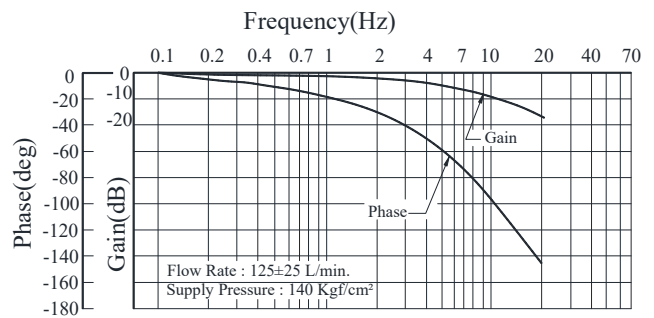

Viscosity Vs. Flow Rate

Oil : ISO VG 46 Oil.

- EFG 03
- EFCG

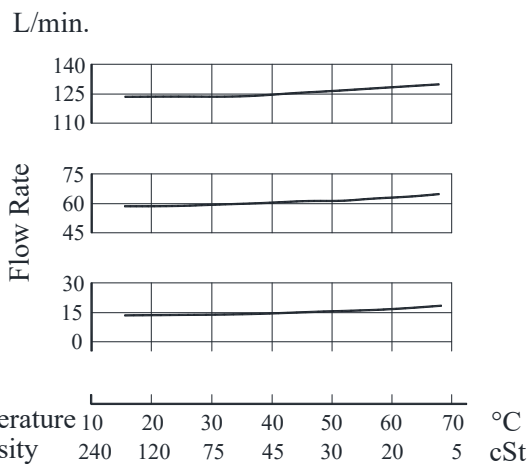

- EFG 06
- EFCG

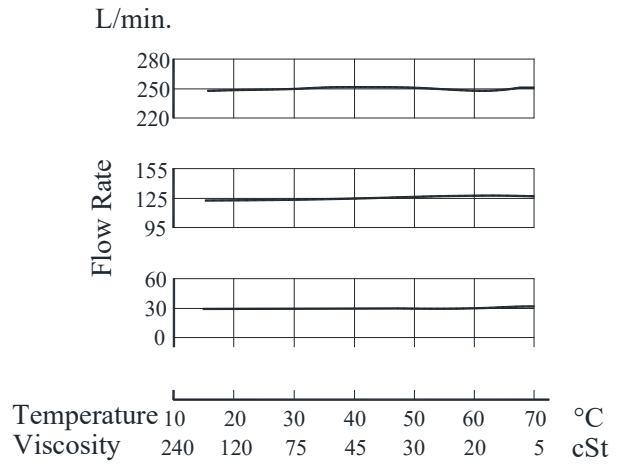

Differential Pressure Vs. Flow

- EFG 03
- EFCG

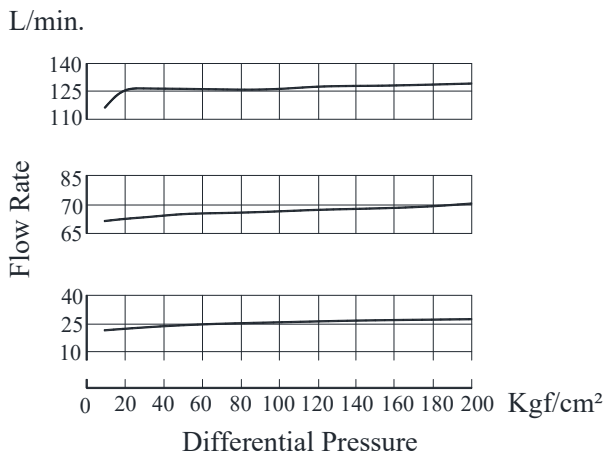

- EFG 06
- EFCG

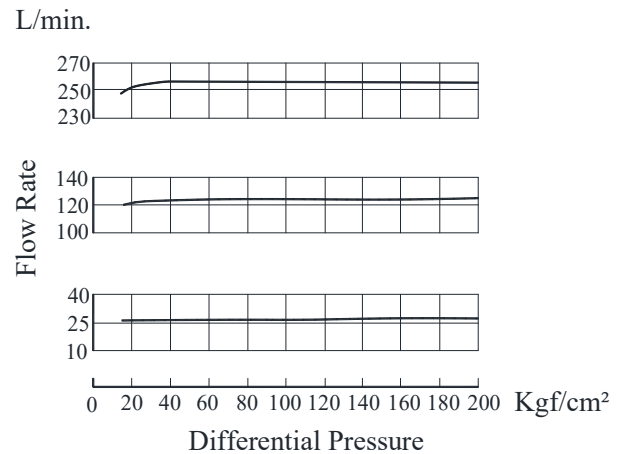

Spare Parts List

- EF※ G-03
- List of Seals

Sl. No.	Name of Parts	Part No.	Qty.
1	O-Ring	SO-NB-G35	1
2	O-Ring	SO-NB-P28	3
3	O-Ring	SO-NB-P26	1
4	O-Ring	SO-NB-P16	1
5	O-Ring	SO-NB-P14	1
6	O-Ring	SO-NB-P9	1
7	O-Ring	SO-NB-P6	2
8	O-Ring	SO-NA-A016	1

- EF※ G-06
- List of Seals

Sl. No.	Name of Parts	Part No.	Qty.
1	O-Ring	SO-NA-P21	1
2	O-Ring	SO-NB-P50	3
3	O-Ring	SO-NB-P46	1
4	O-Ring	SO-NB-P36	1
5	O-Ring	SO-NB-P34	2
6	O-Ring	SO-NB-P32	4*1
7	O-Ring	SO-NA-P21	1
8	O-Ring	SO-NB-P10	2
9	O-Ring	SO-NB-P9	3

*1. Two O-Rings are required for the EFCG.

- Solenoid Assy.

Valve Model Numbers	Solenoid Assy.	Qty.
EF※G-03-※-※-51	E318-Y06M1-28-61	1
EF※G-06-125-※-51		

- List of Seal Kits

Model Numbers	Seal Kit Numbers
EFG-03-※-※-51	KS-EFG-03-51
EFCG-03-※-※-51	KS-EFCG-03-51

Note : When ordering the seals, please specify the seal kit number from the table above.

- List of Seal Kits

Model Numbers	Seal Kit Numbers
EFG-06-250-※-51	KS-EFG-03-51
EFCG-06-250-※-51	KS-EFCG-03-51

Note : When ordering the seals, please specify the seal kit number from the table above.